

O P E R A T I N G M A N U A L

8660C
SYNTHESIZED
SIGNAL GENERATOR

DUPLICATE OF SECTIONS 1 THRU 3
OF YOUR OPERATING AND SERVICE MANUAL
KEEP WITH INSTRUMENT

Printed JANUARY 1981
© Hewlett-Packard Co. 1975, 1977, 1979, 1981





MODEL 8660C

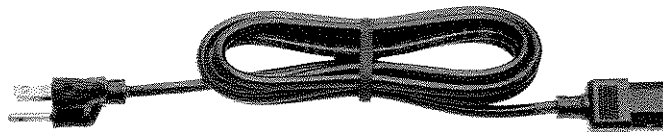

LINE POWER CORD

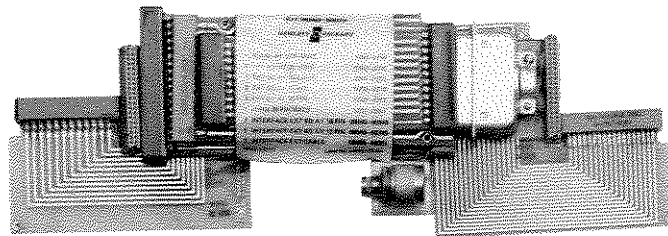

ACCESSORY

Figure 1-1. Model 8660C and Accessories Supplied

SECTION I

GENERAL INFORMATION

1-1. INTRODUCTION

1-2. This manual contains all information required to install, operate, test, adjust and service the Hewlett-Packard Model 8660C Synthesized Signal Generator mainframe. This section covers instrument identification, specifications and other basic information. Figure 1-1 shows a front view of the instrument and accessories supplied.

1-3. The other various sections of this manual provide information as follows:

a. SECTION II, INSTALLATION, provides information relative to incoming inspection, power requirements, mounting, packing for shipment, etc.

b. SECTION III, OPERATION, provides information relative to operating the instrument.

c. SECTION IV, PERFORMANCE TESTS, provides information required to ascertain that the instrument is performing in accordance with published specifications.

d. SECTION V, ADJUSTMENTS, provides information required to properly adjust and align the instrument after repairs are made.

e. SECTION VI, REPLACEABLE PARTS, provides ordering information for all replaceable parts and assemblies.

f. SECTION VII, MANUAL CHANGES, provides manual change information necessary to document all prefixes listed on the title page. In addition, this section also contains recommended modifications for the earlier instrument configurations.

g. SECTION VIII, SERVICE, includes all information required to service the instrument when a malfunction occurs.

1-4. Packaged with this instrument is an Operating Information Supplement. This is simply a copy of the first three sections of this manual (less Table 1-2). This supplement should stay with the instrument for use by the operator. Additional copies of the Operating Information Supplement may be ordered separately through your nearest Hewlett-

Packard office. The part number is listed on the inside title page of this manual below the Manual Part Number.

1-5. Also listed on the inside title page of this manual, below the manual part number, is a "Microfiche" part number. This number may be used to order 4 x 6 inch microfilm transparencies of the manual. Each microfiche contains up to 60 photo-duplicates of the manual pages. The microfiche package also includes the latest Manual Changes Supplement as well as all pertinent Service Notes.

1-6. SPECIFICATIONS

1-7. Instrument specifications are listed in Table 1-1. These specifications are the performance standards or limits against which the instrument may be tested.

1-8. INSTRUMENTS COVERED BY MANUAL

1-9. This instrument has a two-part serial number. The first four digits and the letter comprise the serial number prefix. The last five digits form the sequential suffix that is unique to each instrument. The contents of this manual apply directly to instruments having the same serial number prefix(es) as listed under SERIAL NUMBERS on the inside title page.

1-10. An instrument manufactured after the printing of this manual may have a serial prefix that is not listed on the inside title page. This unlisted serial prefix indicates that the instrument is different from those documented in this manual. The manual for this instrument is supplied with a yellow Manual Changes supplement that contains "change information" that documents the differences.

1-11. In addition to change information, the supplement may contain information for correcting errors in the manual. To keep this manual as current and accurate as possible, Hewlett-Packard recommends that you periodically request the latest Manual Changes supplement for this manual. The supplement for this manual is keyed to this manual's print date and part number, both of

Table 1-1. Model 8660C Specifications (1 of 2)

SPECIFICATIONS

Frequency Selection:

Keyboard control panel allows selection of CW (or center frequency) by entry keys or synthesized tuning dial. Least significant digit either 1 Hz (standard) or 100 Hz (Option 004).*

Reference Oscillator:

Internal: 10 MHz quartz oscillator. Aging rate less than ± 3 parts in 10^8 per 24 hours after 72 hour warmup (± 3 parts in 10^9 per 24 hours after 30 day warmup, Option 001).

External: Rear panel switch allows operation from any 5 MHz or 10 MHz signal at a level between 0.5V and 2.5V rms into 170 ohms. Stability and spectral purity will be partially determined by characteristics of external reference oscillator.

Reference Output:

Rear panel BNC connector provides output of signal selected (INT. or EXT.) at the following levels into 170 ohms:

Internal Reference: 0.75V to 1.5 Vrms.

External Reference: Nominally equal to external input.

Display:

Ten-digit numerical LED display of CW frequency is active in either local or remote mode. Spring-loaded pushbuttons provide display of sweep width, selected step size, or characters being entered on the keyboard.

Synthesized Search:

Synthesized search dial changes the synthesized output frequency 180 steps per revolution (with the 86601A, the COARSE and STEP tuning are desensitized to 36 steps/revolution). Step sizes are 1 Hz, 1 kHz, 1 MHz, or any step size entered through the keyboard.

Digital Sweep:

Type: Symmetrical about CW/center frequency.

Sweep width is divided into 100 synthesized steps for fastest sweep speed or 100 steps for slower speeds or Manual Sweep.

Sweep Width: Continuously adjustable over range of RF section installed. Smallest step size is equal to frequency resolution of mainframe.

Sweep End Point Accuracy: Same as reference oscillator accuracy.

Sweep Speed: Selectable 0.1 sec, 1 sec, or 50 sec per sweep (Auto or Single).

Sweep Output: 0 to +8V stepped ramp, 100 or 1000 equal steps depending on sweep speed.

Manual Sweep: Synthesized search dial allows manual sweep over width selected in 1000 steps (LED display follows output frequency during manual sweep).

Single Sweep: Initiated by momentary contact pushbutton.

Frequency Stepping:

After a step size has been entered on the keyboard, depressing STEP \uparrow or STEP \downarrow button will increment frequency up or down by the desired step size.

Step Accuracy: Same as reference oscillator accuracy.

REMOTE PROGRAMMING

CW frequency, frequency stepping (STEP \uparrow or STEP \downarrow) and output level, and most modulation functions are programmable. Note: digital sweep is NOT programmable.

Frequency:

CW frequency is programmable over entire range with same resolution obtained in manual operation.

Frequency Step:

STEP \uparrow or STEP \downarrow may also be programmed to change output frequency by a previously selected step size.

Output Level:

Programmable in 1 dB steps over the output range of the RF section installed (for output level accuracy see RF section specifications).

Modulation: See specifications for modulation and RF section installed.

Programming Input:

Connector Type: 36 pin Cinch type (mating connector supplied). (Optional HP-IB interface; 24 pin Cinch type 57 (mating connector NOT supplied)).

Logic: TTL compatible (negative true)
"0" logic state corresponds to +2V or higher.

"1" logic state corresponds to +0.8V or lower.

Internal Fan-in from Programming Connector:

10; (required current approximately 15 mA per line in the "1" state).

*When using 86603A RF section above 1300 MHz least significant digit becomes either 2 Hz (standard) or 200 Hz (Option 004).

Table 1-1. Model 8660C Specifications (2 of 2)

GENERAL	
<p>Operating Temperature Range: 0° to +55°C.</p> <p>Leakage: Meets radiated and conducted limits of MIL I-6181D.</p> <p>Power: 100 or 120 Vac, +5 -10% at 48 to 440 Hz. 200 or 240 Vac, +5 -10% at 48 to 66 Hz. 400 VA maximum.</p> <p>Weight: (Mainframe only): Net, 23.2 kg (51 lb), Shipping 28.6 kg (63 lb).</p>	<p>Options:</p> <p>Option 001: $\pm 3 \times 10^{-9}$ /day internal reference oscillator.</p> <p>Option 002: No internal reference oscillator.</p> <p>Option 003: Operation from 50 to 400 Hz line.</p> <p>Option 004: 100 Hz frequency resolution (200 Hz above 1300 MHz center frequency.)</p> <p>Option 005: HP-IB programming interface.</p> <p>Option 100: 11661B factory installed.</p> <p>Option 908: Rack Mounting Kit.</p>

which appear on the inside title page. Complimentary copies of the supplement are available from Hewlett-Packard.

1-12. For information concerning a serial number prefix not listed on the inside title page or in the Manual Changes supplement, contact your nearest Hewlett-Packard office.

1-13. DESCRIPTION

1-14. The Model 8660C Synthesized Signal Generator Mainframe requires two plug-in sections to provide a useable RF output. The plug-ins required are an RF Section and a Modulation (or Auxiliary) Section. These plug-in sections are inserted into the front of the Model 8660C; all operating controls are on the front panels of the plug-in sections or on the mainframe panel.

1-15. An internal plug-in unit, the Frequency Extension Module (HP accessory number 11661) is required when any RF Section other than the HP Model 86601 is in use.

1-16. GENERAL OPERATING PRINCIPLES

1-17. All of the signals generated in the Model 8660C are phase locked, directly or indirectly, to a 100 MHz master oscillator in the reference section. The 100 MHz master oscillator is phase locked to an internal temperature controlled oscillator or to an external standard. Provisions are made for the internal oscillator to be used as a reference signal for other equipment.

1-18. The Model 8660C uses synthesizer techniques to provide digitally controlled, precise RF signals which are used in the RF Section output plug-ins to produce the selected output frequency. The output frequencies are exactly those selected

in 1 Hz or 2 Hz increments in the standard instruments, or in 100 Hz or 200 Hz increments in Option 004 instruments.

1-19. Six phase locked loops, (four in Option 004 instruments), all phase locked to the 100 MHz master oscillator, are used to generate the RF signals used in the RF Section plug-ins to produce the final output signal.

1-20. The Model 8660C output frequency may be selected by front panel controls or by a remote programming device.

1-21. Operating of the plug-in sections may also be remotely programmed through the mainframe circuits.

1-22. Descriptions, operating instructions and service information for the various plug-in sections is provided in separate manuals.

NOTE

The 8660 family, and plug-ins available are described briefly on the first foldout Sheet.

1-23. OPTIONS

1-24. **Option 001:** Reference Oscillator with $\pm 3 \times 10^{-9}$ / per day stability.

1-25. **Option 002:** No internal standard reference oscillator.

1-26. **Option 003:** 50 to 400 Hz ac operation.

1-27. **Option 004:** 100 Hz resolution below 1300 MHz, 200 Hz resolution above 1300 MHz.

1-28. Option 005. Hewlett-Packard Interface Bus installed instead of BCD interface. HP-IB utilizes some ASCII interface codes (also previously referred to as General Purpose Interface Bus).

1-29. Option 100. Adds an internal plug-in, the 11661 (for use with an 86602 or 86603 RF Section) before the instrument is shipped from the factory.

1-30. Option 908. Adds a rack mounting kit. If the 8660C was purchased without the rack mounting option, the kit may be ordered from the nearest Hewlett-Packard office using HP part number 08660-60347.

1-31. EQUIPMENT REQUIRED BUT NOT SUPPLIED

1-32. An RF Section and a Modulation or Auxiliary Section must be installed in the Model 8660C mainframe. In addition when an RF Section such as the 86602 or 86603 is used, the internal Frequency Extension Module (Model 11661) must be used.

1-33. EQUIPMENT AVAILABLE

1-34. A service kit, Hewlett-Packard accessory number 11672A, is recommended for servicing and adjusting the mainframe and the plug-in sections. Contents of the service kit are listed in Table 1-2. Individual items in the kit may be ordered separately if desired.

1-35. ACCESSORIES SUPPLIED

1-36. The following accessories are provided with the Model 8660C:

a. A detachable three-wire power cable. The type of power cord will be determined by the shipment destination.

b. An accessory kit, part number 08660-60070, consisting of the following:

1	Connector, Type N-to-BNC	1250-0780
1	Extender Board, 20 contact	5060-0256
1	Extender Board, 24 contact	5060-0258
2	Extender Boards, 15 contact	5060-0276
1	Extender Board, 18 contact	5060-0277
1	Connector 36 pin with hood and clamp	1251-0084
1	Extender Board A3 Interface, 18 Contact	08660-60348
1	Extender Board A3 Interface, 12 Contact	08660-60349
1	Interface Extender Board Cable	08660-60361

1-37. WARRANTY

1-38. Certification and warranty information for the Model 8660C appears on the inside front cover of this manual.

1-39. TEST EQUIPMENT AND ACCESSORIES

1-40. Table 1-2 lists the test equipment and accessories recommended to test, adjust, and service the Model 8660C.

1-41. ELECTRICAL PROTECTION

1-42. The safety classification of this instrument is Safety Class I.

1-43. This apparatus has been designed and tested to operate in a safe manner. The Operating and Service Manual contains information, warnings and cautions which must be followed by the user to ensure safe operation and to retain safe operating conditions.

SECTION II INSTALLATION

2-1. INTRODUCTION

2-2. This section provides information on incoming inspection, selecting the input line voltage, operating environment, and information applicable to bench and rack mounted operation of the Model 8660C.

2-3. INITIAL INSPECTION

2-4. Inspect the shipping container for damage. If the shipping container or cushioning material is damaged it should be kept until the contents of the shipment have been checked mechanically and electrically. The contents of the shipment are shown in Figure 1-1, and the procedures for checking electrical performance are given in Section IV. If the contents are incomplete, if there is mechanical damage or defects, or if the instrument does not pass the electrical performance test, notify the nearest Hewlett-Packard office. If the shipping container is damaged or the cushioning material shows signs of stress, notify the carrier as well as the Hewlett-Packard office. Keep the shipping materials for the carrier's inspection. The HP office will arrange for repair or replacement without waiting for claim settlements.

2-5. The warranty statement for the instrument is on the inside front cover of this manual. Contact the nearest Sales/Service Office for information relative to warranty claims.

2-6. PREPARATION FOR USE

2-7. Power Requirements.

2-8. The Model 8660C requires a power source of 100, 120, 220, or 240 volts +5%, -10%, 48-66 Hz. Power consumption is approximately 400 VA maximum.

2-9. Line Voltage Selection

CAUTION

To prevent damage to the instrument make the line voltage selection **BEFORE** connecting the line power. Also ensure the line power cord is connected to a line power circuit that is provided with a protective earth contact.

2-10. A rear panel line power module, (A7), permits operation from 100, 120, 220, or 240 Vac.

The number visible in the window (located on the module) indicates the nominal line voltage to which the instrument must be connected.

2-11. To prepare the instrument for operation, slide the fuse compartment cover to the left (the line power cable must be disconnected). Pull the handle marked FUSE PULL and remove the fuse; rotate the handle to the left. Gently pull the printed circuit voltage selector card from its slot and orient it so that the desired operating voltage appears on the top-left side (see Figure 2-1). Firmly push the voltage selector card back into its slot. Rotate the FUSE PULL handle to the right, install a fuse of the correct rating, and slide the fuse compartment cover to the right.

NOTE

For 110-120V line, use 4A slo-blo fuse, HP Stock No. 2110-0635. For 220-240V line, use 2A slo-blo fuse, HP Stock No. 2110-0303.

WARNING

To avoid the possibility of injury or death, the following precautions must be followed before the instrument is switched on:

- a. Note that the protection provided by grounding the instrument cabinet may be lost if any power cable other than the three-pronged type supplied is used to couple the ac line voltage to the instrument.
- b. If this instrument is to be energized via an autotransformer to reduce or increase the line voltage, make sure that the common terminal is connected to the earthed pole of the power source.
- c. The power cable plug shall only be inserted into a socket outlet provided with a protective earth contact. The protective action must not be negated by the use of an extension cord without a protective conductor (grounding).
- d. Before switching on the instrument, the protective earth terminal of the instrument must be connected to a protective conductor of the power cord. This is accomplished by ensuring that the instrument's internal earth terminal is correctly connected to the instrument's chassis and that the power cord is wired correctly.

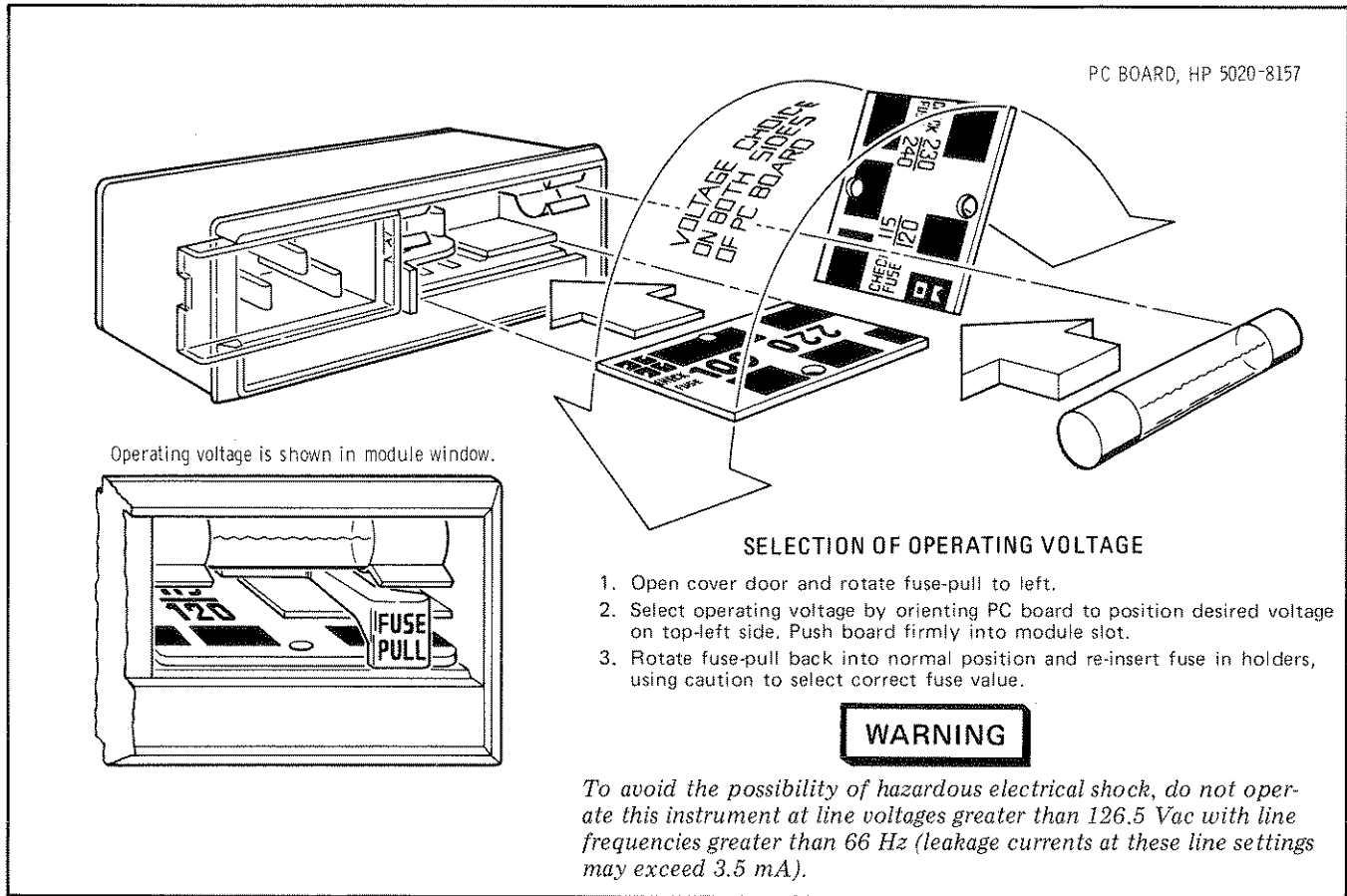

Figure 2-1. Line Voltage Selection

NOTE

The correct fuse rating for the line voltage selected is listed on the line power module. More information about fuses is given in the table of replaceable parts in Section VI (reference designation is A7F1).

2-12. Power Cable

2-13. In accordance with international safety standards, this instrument is equipped with a three-wire power cable. When connected to an appropriate power line outlet, this cable grounds the instrument cabinet. The type of power cable plug shipped with each instrument depends on the country of destination. Refer to Figure 2-2 for the part numbers of the power cable plugs available.

2-14. Mating Connectors

2-15. Internal mating connectors between the Model 8660C and the plug-in sections are in fixed positions. Refer to Figure 8-132 for plug-in con-

necter information. Refer to Figure 8-109 for information relative to the remote control connector, J3.

2-16. Operating Environment

2-17. The operating environment should be within the following limitations:

- Temperature 0 C to +55°C
- Humidity <95% relative
- Altitude <4600 metres (15 000 feet)

2-18. A forced air cooling system is used to maintain the operating temperature required by the instrument. The air exhaust fan is located on the rear panel of the instrument; the air intake is through the side panels of the instrument. When operating the instrument, choose a location that provides at least three inches of clearance at the rear and at least an inch of clearance for each side. The clearances provided by the plastic feet in bench stacking and the filler strip in rack mounting are adequate for the top and bottom cabinet surfaces.

 <p>220/240V OPERATION</p> <p>PLUG*: SEV 1011.1959-24507 TYPE 12 CABLE*: HP 8120-2104</p>	 <p>220/240V OPERATION</p> <p>PLUG*: NZSS 198/AS C112 CABLE*: HP 8120-1369</p>	 <p>100/120V OPERATION</p> <p>PLUG*: NEMA 5-15P CABLE*: 8120-1378</p>	 <p>220/240V OPERATION</p> <p>PLUG*: NEMA 6-15P CABLE*: HP 8120-0698</p>
 <p>220/240V OPERATION</p> <p>PLUG*: CEE7-VII CABLE*: HP 8120-1689</p>	 <p>220/240V OPERATION</p> <p>PLUG*: CEE22-V1 CABLE*: HP 8120-1860</p>	 <p>220/240V OPERATION</p> <p>PLUG*: BS 1363A CABLE: HP 8120-1351</p>	
<p>*The number shown for the plug is the industry identifier for the plug only. The number shown for the cable is an HP part number for a complete cable including the plug.</p>			

Figure 2-2. Power Cable HP Part Numbers

2-19. Bench Operation

2-20. The instrument has plastic feet and a fold-away tilt stand for convenience in bench operation. The tilt stand raises the front of the instrument for easier viewing of the control panel and the plastic feet are shaped to make full width modular instruments self aligning when stacked.

2-21. Rack Mounting (Option 908)

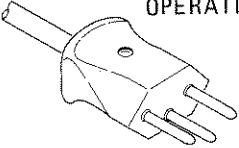
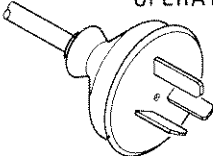
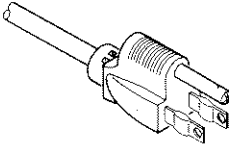
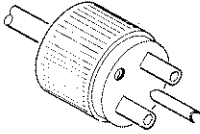
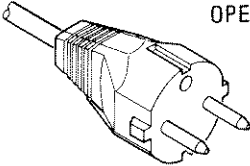
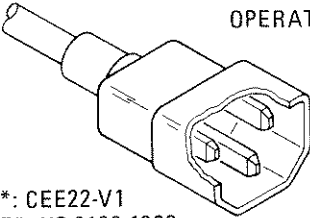
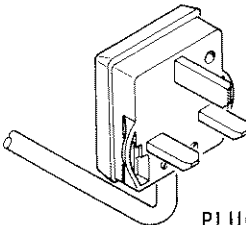
2-22. The 8660C Option 908 is supplied with a rack mounting kit. This kit contains all the necessary hardware and installation instructions for mounting the instrument in a rack with 19-inch spacing (see Figure 2-3). The HP part number for this kit is 08660-60347.

2-23. STORAGE AND SHIPMENT

2-24. Environment

2-25. The instrument should be stored in a clean, dry environment. The following environmental limitations apply to both storage and shipment:

- Temperature -40°C to +75°C
- Humidity <95% relative
- Altitude <7600 metres (25 000 feet)

2-26. Packaging

2-27. **Tagging for Service.** If the instrument is being returned to Hewlett-Packard for service, please

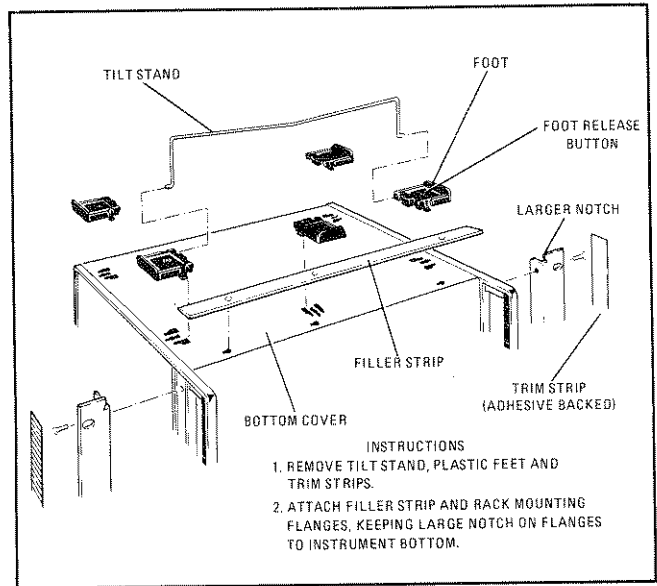

Figure 2-3. Preparation for Rack Mounting

complete one of the blue repair tags located at the end of this manual and attach it to the instrument.

2-28. **Original Packaging.** Containers and materials identical to those used in factory packaging are available through Hewlett-Packard offices. If the instrument is being returned to Hewlett-Packard for servicing, attach a tag indicating the type of service required, return address, model number, and full serial number. Also, mark the container FRAGILE to assure careful handling. In any correspondence, refer to the instrument by model number and full serial number.

2-29. Other Packaging. The following general instructions should be used for re-packaging with commercially available materials:

a. Wrap the instrument in heavy paper or plastic. (If shipping to a Hewlett-Packard office or service center, attach a tag indicating the type of service required, return address, model number, and full serial number.)

b. Use a strong shipping container. A double-wall carton made of 2.4 MPa (350 psi) test material is adequate.

c. Use enough shock-absorbing material (75–100 mm; 3 to 4-inch layer) around all sides of the instrument to provide firm cushion and prevent movement inside the container. Protect the control panel with cardboard.

d. Seal the shipping container securely.

e. Mark the shipping container **FRAGILE** to assure careful handling.

SECTION III OPERATION

3-1. INTRODUCTION

3-2. This section provides operating instructions for the Hewlett-Packard Model 8660C Synthesized Signal Generator mainframe for both the local and remote modes.

3-3. The Model 8660C is designed to provide precise digitally controlled signals for use in plug-in sections which provide the selected output frequency with the chosen modulation parameters. It will be necessary to have the operating manuals for the plug-in sections being used in order to efficiently operate the instrument.

NOTE

If a Modulation plug-in Section is not used it will be necessary to have an Auxiliary Section in place of the Modulation Section. The Auxiliary Section completes a signal path from the mainframe to the RF Section plug-in and also provides a means of modulating the RF Section from an external source.

3-4. PANEL FEATURES

3-5. Front and rear panel controls, indicators and connectors of the 8660C are shown, and their functions described, in Figure 3-1.

3-6. OPERATOR'S MAINTENANCE

3-7. Operator's maintenance of the Model 8660C Synthesized Signal Generator mainframe is limited to fuse replacement.

3-8. OPERATING PRINCIPLES

3-9. The Model 8660C may be operated by front panel controls in the local mode or externally programmed in the remote mode. Allow the system to warm up for 15 minutes before operating.

WARNING

The power requirements and safety precautions listed throughout this Manual must be observed to preserve the built-in safety features of the Model 8660C.

3-10. LOCAL OPERATION

3-11. In the local mode of operation, all functions of the mainframe are controlled by front panel controls, except when an external reference oscillator is used. When an external reference oscillator is used, the rear panel SELECTOR switch must be in the EXT position.

3-12. The 20-key keyboard may be used to:

a. Select any frequency within the range of the RF Section plug-in in 1 Hz increments (above 1300 MHz, 2 Hz increments) for standard instruments. Option 004 instruments are selectable in 100 Hz increments (above 1300 MHz, 200 Hz increments).

NOTE

Frequencies which are above the output frequency range of the RF Section, if selected, will be stored in the keyboard register, but the information will not be transferred to the center frequency register. The center frequency register and the readout will retain the last valid input. Frequencies below the output frequency range of the RF Section will be transferred to the center frequency register and the output register; the output frequency will be accurate but the output amplitude will be degraded. As an example, the Model 86601A RF Section has a specified lower frequency limit of 10 kHz, but typically will produce a useable RF output down to 3 kHz or lower.

b. When frequencies below the RF Section frequency range are selected, the OUT OF RNG lamp lights and remains lit.

c. Select any desired sweep width within the frequency range of the RF Section in use. See paragraph 3-14 for further details of sweep operation.

d. Select any incremental step within the frequency range of the RF Section in use. See

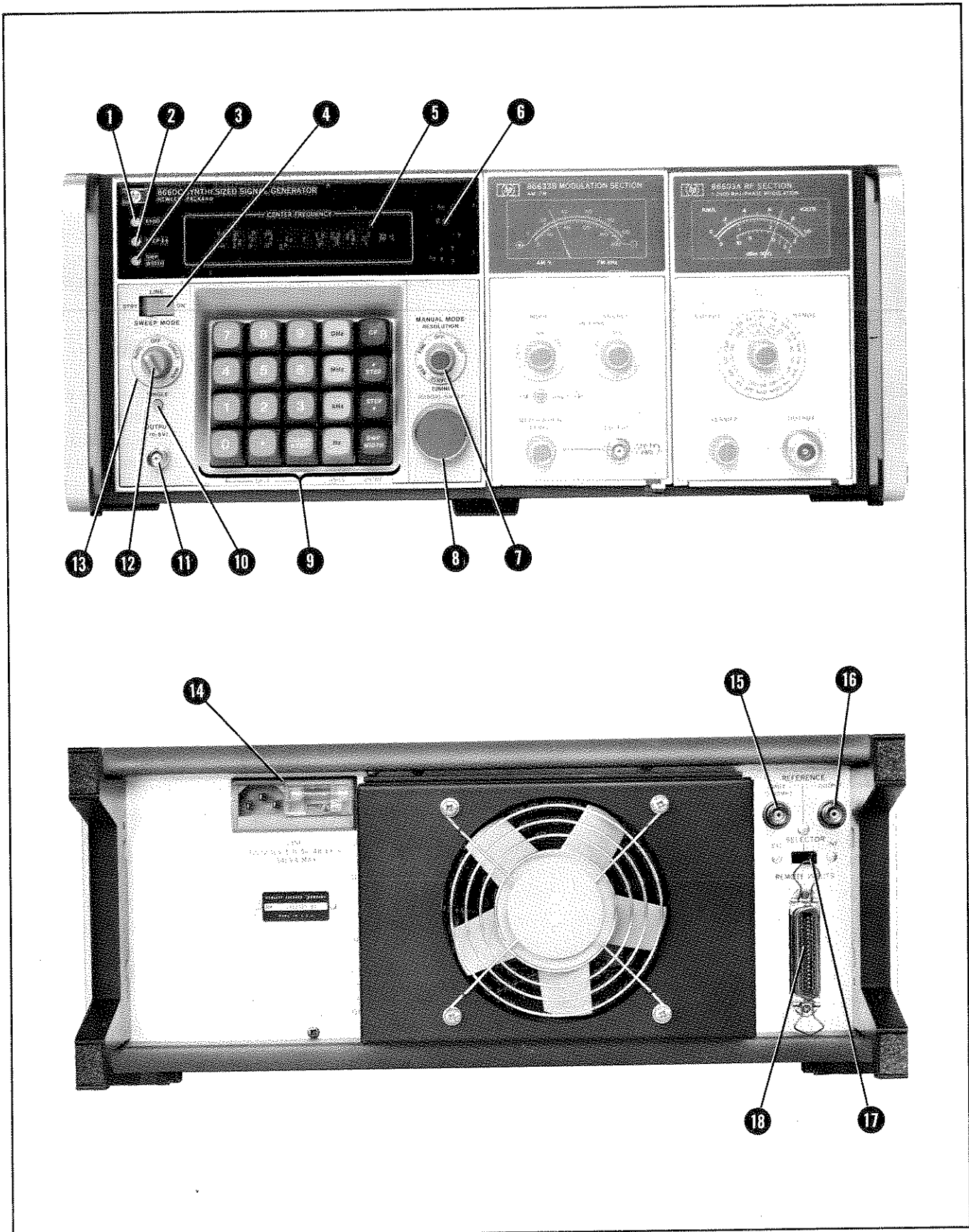

Figure 3-1. Front and Rear Panel Controls, Indicators and Connectors (1 of 2)

- 1 **KYBD pushbutton.** When pressed, causes the information stored in the keyboard storage register to be displayed on the CENTER FREQUENCY readout.
- 2 **STEP pushbutton.** When pressed, causes the information stored in the step storage register to be displayed on the CENTER FREQUENCY readout.
- 3 **SWP WIDTH pushbutton.** When pressed, causes the information stored in the sweep width storage register to be displayed on the CENTER FREQUENCY readout.
- 4 **LINE STBY – ON switch.** In the STBY position, with the instrument connected to the ac line source, the reference oscillator oven temperature is maintained at the operating temperature to avoid the necessity of allowing for a warm up period each time the instrument is used.
- 5 **CENTER FREQUENCY readout.** Normally displays the output center frequency of the RF Section.
- 6 **ANNUNCIATOR.** Provides visual display of mode of operation, crystal oven temperature and out of range frequency selection.
- 7 **MANUAL MODE RESOLUTION.** Works in conjunction with the TUNING control to step the rf output in steps of 1 Hz (FINE), 1 kHz (MED) and 1 MHz (COARSE). In the STEP position the TUNING control steps the rf output frequency by the step stored in the step register.
- 8 **TUNING – MANUAL SWEEP.** Works as specified in the MANUAL MODE RESOLUTION description. May also be used to set the rf output to any point within the limits stored in the sweep register when the SWEEP MODE switch is set to MAN.
- 9 **Keyboard.** Contains 20 keys which are used to enter data or instructions as follows:
 - Numerals 0 through 9
 - Decimal Point (.)
 - CLEAR KYBD. Clears keyboard register (does NOT clear other registers).
 - GHz, MHz, kHz and Hz select frequency in conjunction with numeric keys.
 - CF. Transfers keyboard storage register data to the center frequency register.
 - STEP. ↑ Transfers keyboard storage register data to the step register and steps the center frequency up. May also be used to step the frequency up by the step stored in the step register without a new keyboard entry.
 - STEP. ↓ Same as STEP ↑ except that frequency is stepped down.
 - SWP WIDTH. Transfers the data in the keyboard storage register to the sweep register.
- 10 **SINGLE pushbutton.** In the SINGLE mode, when pressed, causes the rf output to be swept, one time only, across the range stored in the sweep register, at a speed determined by the RATE switch.
- 11 **OUTPUT (0 to +8V).** Provides a sweep ramp for use in external equipment (oscilloscopes, X-Y recorders, etc.) when operating in the swept mode.
- 12 **RATE switch.** The rate switch selects sweep rates as follows: FAST – 100 steps at 1 millisecond per step, MED – 1000 steps at 1 millisecond per step, and SLO – 1000 steps at 50 milliseconds per step.
- 13 **SWEEP MODE switch.** With the sweep mode switch in the AUTO position sweep operation is automatic; the output rf is swept about the center frequency by the data stored in the sweep register at the rate selected by the RATE switch. In the SINGLE mode the rf output is swept once each time the SINGLE pushbutton is pressed. In the MAN mode the sweep is controlled by the MANUAL TUNE control and the data stored in the sweep register.
- 14 **LINE MODULE.** Contains a means of switching input line voltage to 100/120/220/240 Vac +5% –10%, fuse, line cable connector and filtering. NOTE: the cabinet (earth) ground is also applied through the line module.
- 15 **REFERENCE INPUT.** Used when an external standard of 5 or 10 MHz is used.
- 16 **REFERENCE OUTPUT.** Provides the capability of using the internal reference as a time base in external equipment.
- 17 **SELECTOR.** Selects INT or EXT reference.
- 18 **REMOTE INPUTS.** When the instrument is operated in the remote mode (pin 5 of this connector is grounded by the programming device), all functions of the instrument are controlled by the remote programming device. Front panel controls (except for LINE STBY-ON) have no effect on operation of the instrument.

Figure 3-1. Front and Rear Panel Controls, Indicators and Connectors (2 of 2)

paragraph 3-18 for further details of incremental step operation.

3-13. Operating Modes

3-14. Sweep. In the sweep mode the sweep width is selected by the keyboard. The sweep width may be displayed on the CENTER FREQUENCY readout by pressing the SWP WIDTH pushbutton to the left of the readout. Only the center frequency is shown in the AUTO or SINGLE SWEEP modes. In the MAN sweep mode the actual RF output frequency of the RF Section will be displayed.

3-15. When the SWEEP MODE switch is placed in the AUTO position the output signal of the RF Section is swept about the selected center frequency by the selected sweep width. (Example: center frequency 50 MHz, sweep width 20 MHz, the RF output is swept from 40 to 60 MHz.) The sweep rate, selected by the RATE switch is as follows: FAST — 100 steps at 1 millisecond per step, MED — 1000 steps at 1 millisecond per step and SLO — 1000 steps at 50 milliseconds per step.

3-16. When the SWEEP MODE switch is placed in the SINGLE position, pressing the SINGLE pushbutton causes the output of the RF Section to be swept one time. When the single sweep is completed, the output of the RF Section returns to the selected center frequency. The sweep width and sweep rate are selected in the same manner as they are in the AUTO mode.

3-17. When the SWEEP MODE switch is placed in the MAN position the step rate of the output frequency of the RF Section may be manually controlled by the MANUAL SWEEP control. In this mode the sweep width is still controlled by the information in the sweep register. The selected sweep width, in this mode, is divided by 1000 and the output of the RF Section may be controlled in frequency steps that are 1/1000 of the sweep width. (Example: center frequency 50 MHz, sweep width 20 MHz, output may be swept manually from 40 to 60 MHz in 20 kHz steps.)

3-18. Step. The center frequency may be stepped up or down, in any increment within the frequency range of the RF Section in use. The increment selected, including units, must be entered in the keyboard before the STEP ↑ or STEP ↓ key is pressed. The step entered into the step register remains in the register until changed (or the instrument is placed; in the standby mode) and may

be displayed on the readout by pressing a STEP pushbutton.

3-19. When the MANUAL SWEEP control, a Rotary Pulse Generator, is used to control the STEP mode, the size of the step is determined by the information stored in the STEP register.

3-20. Manual. Manual mode operation is essentially the same as the step mode except that increments selected by the MANUAL MODE switch are 1 Hz (FINE), 1 kHz (MED) and 1 MHz (COARSE). These increments are controlled only by the TUNING control when the MANUAL MODE switch is placed in the selected position.

3-21. Combined. The sweep mode, step mode and manual mode may all be used simultaneously except for Manual Sweep which locks out the Manual Tuning Mode. This feature allows the user to quickly determine the frequency parameters of any device being tested.

3-22. Operator's Checks

NOTE

If the instrument is returned for service, be sure to attach a blue repair tag (located at the end of this manual) with failure information.

3-23. During final checkout at the factory the Model 8660C Synthesized Signal Generator mainframe is adjusted for proper operation. No adjustments should be required when the instrument is received. The operator's checks listed in Table 3-1 are based on the assumption that properly operating RF Sections and Modulation Sections are in place during the tests. Refer to the manuals for the specific plug-ins for operating parameters.

3-24. The steps listed in Table 3-1 need not be followed in the sequence listed. Their purpose is to aid the operator in familiarizing himself with the instrument, and to provide assurance that all functions of the instrument are operating properly.

NOTE

1. Numbers shown in the "Result" column of Table 3-1 are those which should be displayed on the CENTER FREQUENCY readout.
2. Any operator's checks specified in the plug-in Manuals should also be performed.

3-25. Modulator Units

3-26. Since the modulator plug-ins are not affected by the mainframe except for digital control

Table 3-1. Operator's Checks (1 of 4)

Step	Operation	Result
<p>NOTE</p> <p><i>All references to CF or other readouts are displayed on the mainframe CENTER FREQUENCY readout.</i></p>		
<p>1 1-a 1-b 1-c</p>	<p>Initial turn-on.</p> <p>Set the rear panel line select switch in the power line module to be compatible with the available line power.</p> <p>Connect the instrument to the power outlet; use ground pin adapter for electrical systems having no ground outlet.</p> <p style="text-align: center;">NOTE</p> <p><i>The instrument should remain connected to the power source in the STBY (standby) mode when not in use. This will maintain constant temperature in the crystal oven and eliminate the need for a warmup period.</i></p> <p>Place the LINE STBY/ON switch in the ON position. Allow the system to warm up for 15 minutes before operating.</p>	<p>Cooling fan starts. CF 1.000000 MHz.</p>
<p>2 2-a 2-b 2-c 2-d 2-e</p>	<p>Keyboard Register and Readout Checks.</p> <p>Hold in KYBD pushbutton and enter 1.234567890. Note that readout input steps from right to left.</p> <p>With KYBD pushbutton held in: Press GHz key Press MHz key Press kHz key Press Hz key</p> <p>Release KYBD pushbutton</p> <p>Press KYBD pushbutton</p> <p>With KYBD pushbutton held in: Press kHz key Press MHz key Press GHz key Press CLEAR KYBD key</p>	<p>Units lights (GHz, MHz, kHz, Hz) are off.1.234567890</p> <p>1.234567890 GHz 1.234567 MHz 1.234 kHz 1 Hz</p> <p>1.000000 MHz</p> <p>1 Hz</p> <p>1.000 kHz 1.000000 MHz 1.00000000 GHz 0000000000</p>
<p>3 3-a 3-b 3-c 3-d 3-e</p>	<p>Step $\uparrow\downarrow$ register and OUT OF RNG Annunciator Check with the 86601A RF Section.</p> <p>Enter 109.000000 MHz CF on keyboard. Enter 111111 Hz STEP \uparrow on keyboard</p> <p>Press the KYBD pushbutton Release the KYBD pushbutton</p> <p>Press the STEP \uparrow key until the readout shows. Note that readout has increased in steps of 111111 Hz.</p> <p>Press the STEP \uparrow key one more time.</p> <p>Place the MANUAL MODE switch in the STEP position and turn the TUNING control counterclockwise. Place the MANUAL MODE switch in the OFF position.</p>	<p>109.000000 MHz 109.111111 MHz 111111 Hz 109.111111 MHz 109.999999 MHz</p> <p>109.999999 MHz OUT OF RNG light flashes once.</p> <p>Readout decreases in 111111 Hz steps.</p>

Table 3-1. Operator's Checks (2 of 4)

Step	Operation	Result
3-f	Enter 10 kHz CF on the keyboard Enter 1 Hz STEP ↑ on the keyboard Press STEP pushbutton Press STEP ↓ key twice With the Model 86601A RF Section the specified lower frequency limit is 10 kHz. <p style="text-align: center;">NOTE</p> <i>The Model 86601A RF Section lower frequency limit is specified at 10 kHz. The output frequency is accurate down to 1 Hz and the output power level is typically accurate down to 3 kHz or less. However, the output signal should be considered unusable below 1.5 kHz.</i>	10.000 kHz 10.001 kHz 1 Hz 9.999 kHz OUT OF RNG light stays on.
3-g	Enter 3 kHz CF on the keyboard Enter 100 Hz STEP ↓ Repeatedly press the STEP ↓ key. Note that the CF readout decreases in 100 Hz steps. The RF output level will typically start to drop below 2 kHz.	3.000 kHz 2.900 kHz OUT OF RNG light on
4	STEP ↑ ↓ register and OUT OF RNG annunciator check with the 86602A RF Section. 4-a Enter 1200.000000 MHz CF on keyboard. Enter 11.111111 MHz STEP ↑ on keyboard. 4-b Press KYBD pushbutton Release KYBD pushbutton 4-c Continue pressing STEP ↑ key until readout displays: 4-d Press the STEP ↑ key one more time. 4-e Set the MANUAL MODE switch to the STEP position and turn the TUNING CONTROL counterclockwise. 4-f Enter 1 MHz CF on the keyboard Enter 1 Hz STEP ↑ on the keyboard Press STEP pushbutton Press STEP ↓ on keyboard twice	1200.000000 MHz 1211.111111 MHz 11.111111 MHz 1211.111111 MHz 1299.999999 MHz 1299.999999 MHz OUT OF RNG light flashes once. Readout decreases in 11.111111 MHz steps. 1.000000 MHz 1.000001 MHz 1 Hz OUT OF RNG light stays on.
5	STEP ↑ ↓ register and OUT OF RNG annunciator check with the 86603A RF Section. 5-a Enter 2500.000000 MHz CF on keyboard Enter 11.111111 MHz STEP ↑ on keyboard 5-b Press KYBD pushbutton Release the KYBD pushbutton 5-c Continue pressing STEP ↑ key until readout displays: <p style="text-align: center;">NOTE</p> <i>The frequency increase alternates between 11.111110 and 11.111112 MHz due to the 2 Hz resolution of center frequencies ≥ 1300 MHz).</i>	2500.000000 MHz 2511.111110 MHz 11.111111 MHz 2511.111110 MHz 2599.999998 MHz

Table 3-1. Operator's Check (3 of 4)

Step	Operation	Result
5-d	Press the STEP ↑ key one more time	2599.999998 MHz OUT OF RNG light flashes once.
5-e	Set the MANUAL MODE switch to the STEP position and turn the TUNING CONTROL counterclockwise.	The readout decrease is in 11.111110 or 11.111112 MHz steps (to a minimum of .000025 MHz).
5-f	Enter 1 MHz CF on the keyboard Enter 1 Hz STEP ↑ on the keyboard Press STEP pushbutton Press STEP ↓ on keyboard twice	1.000000 MHz 1.000001 MHz 1 Hz .999999 MHz OUT OF RNG light stays on.
6	<p>MANUAL MODE — MANUAL TUNING Check (With 86601A)</p> <p style="text-align: center;">NOTE</p> <p style="text-align: center;"><i>The upper frequency limit for 86602A/B RF Section is 1299.999999 MHz; for 86603A, 2599.999998 MHz</i></p>	
6-a	Set the SWEEP MODE switch to OFF and enter 0 MHz CF	.000000 MHz and OUT OF RNG light is on.
6-b.	Set the MANUAL MODE switch to COARSE and rotate the TUNING control clockwise until the readout indicates: Note that the readout steps in 1 MHz increments.	109.000000 MHz
6-c	Set the MANUAL MODE switch to MED and rotate the TUNING control clockwise until the readout indicates: Note that the readout steps in 1 kHz increments.	109.999000 MHz
6-d	Set the MANUAL MODE switch to FINE and rotate the TUNING control clockwise until the readout indicates: Note that the readout steps in 1 Hz increments.	109.999999 MHz
7	<p>Sweep Mode Checks with 86601A RF Section.</p> <p style="text-align: center;">NOTE</p> <p style="text-align: center;"><i>Proper operation of the instrument in the sweep mode is best verified with a spectrum analyzer. However, operation of the sweep function can be verified by front panel indications as described in steps 7-a and 7-b.</i></p>	
7-a.	Set CF to 5 kHz and SWP WIDTH to 10 kHz. Place the SWEEP MODE switch in the AUTO position and the RATE switch in the SLO position.	SWEEP and OUT OF RNG lights on. RF Output meter level drops every 50 seconds.

Table 3-1. Operator's Check (4 of 4)

Step	Operation	Result
7-b	Set CF to 10 kHz. Other functions as in step 7-a.	SWEEP LIGHT remains lit. OUT OF RNG light alternates, 25 seconds on, 25 off.
7-c	Connect the RF output to the RF INPUT of the spectrum analyzer. Enter 10 MHz CF and 10 MHz SWP WIDTH and SWEEP MODE to AUTO. Position the RATE switch to MED and adjust the spectrum analyzer for a clear display. Enter 5 MHz STEP and step the frequency across the RF range.	Readout increases in 5 MHz steps. Sweep continues to be 5 MHz on each side of the CF.
8 8-a 8-b 8-c	Sweep Mode Checks with 86602A, 86602B or 86603A RF Sections. Set CF to 5 MHz Set SWP WIDTH to 10 MHz Set SWEEP MODE to AUTO and RATE switch to SLO Set CF to 1 MHz Set CF to 5 MHz on keyboard. Set SWEEP RATE switch to MED	5.000000 MHz 5.000000 MHz 5.000000 MHz OUT OF RNG light flashes every 50 s. RF Section meter also dips. SWEEP light remains on. 1.000000 MHz SWEEP light on. OUT OF RNG light on every 25 s. 5.000000 MHz OUT OF RNG light flashes on at 1 s rate.
9 9-a	Manual Sweep Check Enter 50 MHz CF and 10 MHz SWP WIDTH. Place the SWEEP MODE switch in the MAN position. Rotate the MANUAL SWEEP control through its range.	CF is tuneable from 45 to 55 MHz.
10 10-a	Single Sweep Check Enter 50 MHz CF and 20 MHz SWP WIDTH and place the SWEEP MODE switch in the SINGLE position. Press the SWP WIDTH pushbutton. Connect the RF output to the RF INPUT of the spectrum analyzer to display the 50 MHz signal. Press the SINGLE pushbutton.	50.000000 MHz 20.000000 MHz Spectrum analyzer display is swept once from 40 to 60 MHz.

voltages, operator's checks for the modulators are not included in Table 3-1. Refer to the individual manuals for the modulator plug-in in use for applicable operator's checks.

3-27. RF Units

3-28. Many of the tests specified in Table 3-1 do not apply specifically to an RF Section. Those checks which are not referred to a specific RF Section apply equally to the Model 86601, 86602, and the 86603. When procedures apply to specific RF Sections only, this information is conveyed following the procedure.

NOTE

Most of the programming tables in this section apply equally to local and remote modes.

3-29. REMOTE OPERATION

3-30. There are currently two means of remotely programming the Model 8660C. They are BCD (Binary Coded Decimal) and HP-IB (Hewlett-Packard Interface Bus). In the text which follows, programming and other requirements which are common to both means will be discussed first, then BCD requirements, and finally HP-IB requirements.

3-31. General Programming Requirements

3-32. There are several conventions which must be observed when remotely controlling the Model 8660C. Besides providing data with the least significant digit first, these conventions include:

- a. All output levels are referenced to +13 dBm. This reference operation involves subtracting 13 from the desired output level.
- b. There are three separate modulation parameters which may be programmed; source, type and %. Source and type are combined into one number (source is the least significant digit).
- c. When in the remote mode, all front panel controls except the LINE STBY/ON and FM CAL controls are inhibited.
- d. Digital sweep may not be operated in the remote mode of operation.
- e. When changing from the local to the remote mode of operation the temporary storage

register should be cleared before a remote entry is made.

f. The data level inputs to the Model 8660C are as follows: approximately 0 volts (TTL LOW) = 1 and approximately 2.8V (TTL HIGH) = 0 (sometimes referred to as negative or ground true logic).

3-33. BCD Remote Operation

3-34. The following information pertaining to BCD programming, does not apply to HP-IB programming.

3-35. In BCD remote operation two four-bit parallel codes are applied to the instrument circuits through a rear panel connector (J3). These inputs, if numeric data, are converted to BCD digit serial information and clocked into a temporary storage register. If the inputs are address information they are clocked into a temporary storage register. If the inputs are address information they are used to direct a clock to strobe the data from the temporary storage register into the desired final storage register.

3-36. When all of the significant data entries have been stored in the temporary storage registers, the least significant digit is stored in a position to allow it to be the first digit strobed out, then the next least significant digit, etc, so that the information will be stored in the appropriate register in the same sequence in which it was received.

3-37. Operation of the storage registers not located in the Model 8660C mainframe is detailed in the manuals for the plug-in sections. Table 3-3 provides examples of programming the registers which may be programmed when the Model 8660C mainframe is used.

3-38. Refer to Figures 3-2 and 3-3 for timing information and to Table 3-5 for interconnection information.

NOTE

Although it is not necessary to program frequency first, then modulation (if any), then attenuation, this sequence minimizes the time required for entering data.

3-39. **Data Inputs.** Data inputs (logic 1=0) must be referenced to the command pulse as shown in

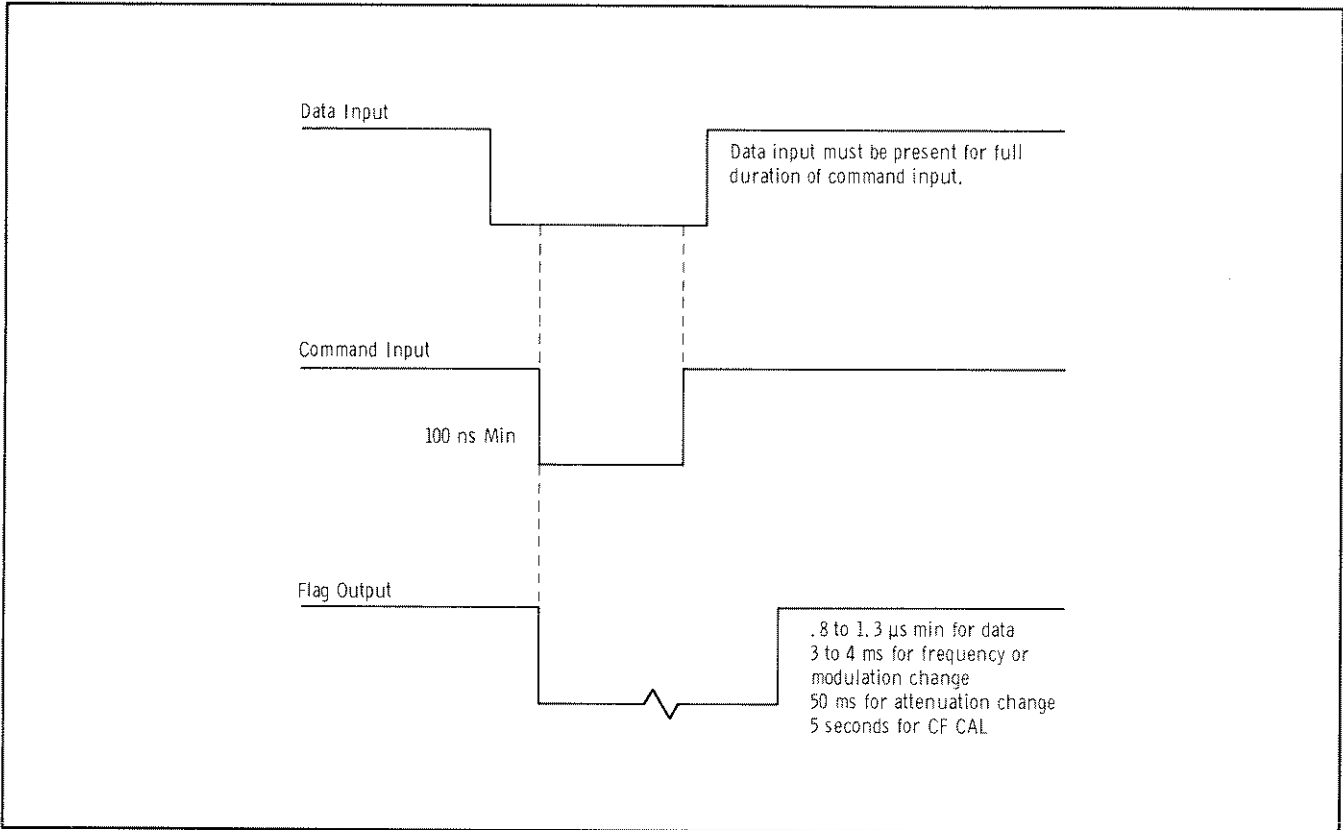

Figure 3-2. Model 8660C Data Input Timing

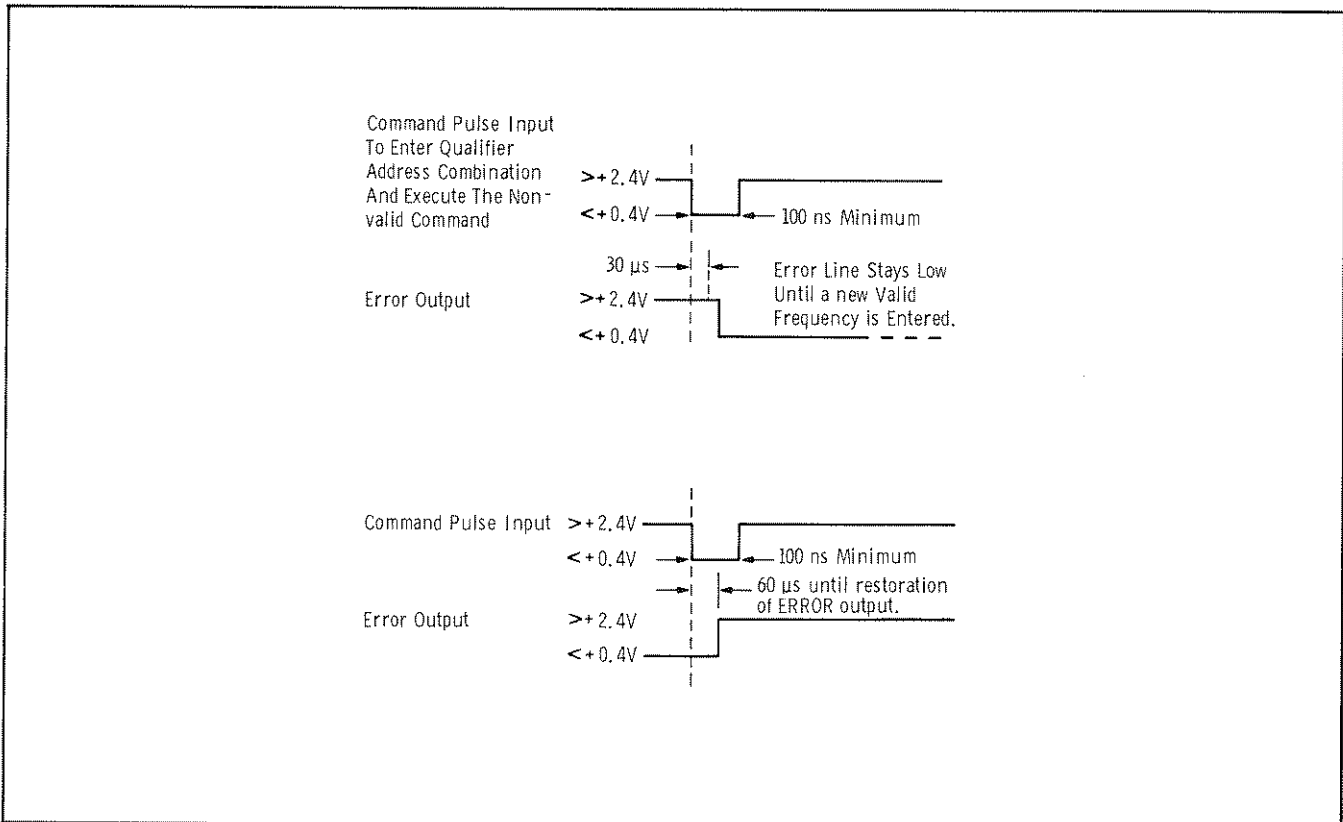

Figure 3-3. Model 8660C Error Output Timing

Figure 3-2. The data inputs may be terminated after the command pulse trailing edge.

3-40. The command pulse causes the input data to be stored in the temporary storage register or, if the data input is an address, to be stored in one of the final storage registers. These pulses are logic 1 (0V) pulses of 100 nanoseconds minimum width, maximum frequency of 500 kHz. Pulses for low transfer frequencies may be wider if consistent with the duty cycle. The leading edge must have a fall time of 100 nanoseconds or less. Transfer occurs on the leading edge of the pulse. Note that data must be held until the command pulse terminates. The flag signal is also initiated by the falling (leading) edge of the command pulse.

3-41. **Flag Signal.** The flag signal indicates receipt and execution of the command pulse from the remote programming device. The flag signal will be logic 1 (0V). Duration of the signal will depend on the function programmed.

3-42. **Error Signal.** Indicates frequency out of range or crystal oven temperature is not stabilized. The error signal will be at a logic 1 (0V) for the period of the function error (see Figure 3-3).

3-43. **Reset.** Controls the DCU circuits in the same manner as the DCU power detect circuit does when the instrument is first turned on. It also initializes circuitry and resets the data registers. Requires a logic 1 (0V) level which may be as short as 5 microseconds.

NOTE

When switching from remote to local operation clear the keyboard before making an entry.

3-44. HP-IB Remote Operation

3-45. HP-IB (Hewlett-Packard Interface Bus) is a general purpose interface system. Although the

Table 3-2. Storage Register Addresses

Name of Register	Address 0=High, 1=Low	Location	Function
Center Frequency	0000 (0)	Mainframe	To set Center Frequency
Step ↑	0001 (1)	Mainframe DCU	To step center frequency up in any increment
Step ↓	0010 (2)		To step center frequency down in any increment
Attenuator	0011 (3)		RF Section plug-in
AM-FM Function	0100 (4)	Modulation Section plug-in	Selects Modulation Function
AM-FM%	0101 (5)	Modulation Section plug-in	*Selects AM % of Modulation or FM Deviation
FM CAL 86635 or 86632 only	0110 (6)	Modulation Section plug-in	Phase locks 20 MHz FM oscillator to the reference loop 20 MHz

*The 86632B and the 86635A require inputs of one half of the desired deviation in remote mode.

Table 3-3. Model 8660C Programming Examples (1 of 3)

EXAMPLE 1. Set 100.000000 MHz Center Frequency (CF)			
Input		Temporary Register	CF Register
0=High	1=Low		
Data:	D ₁ 0001 (1) D ₂ 0000 (0)	00 00 00 00 00	Last Input
	Temporary Command	01 00 00 00 00	Last Input
	Address: D ₁ 1111 (15) D ₂ 0000 (0)	01 00 00 00 00	Last Input
	Transfer Command	00 00 00 00 00	01 00 00 00 00
EXAMPLE 2. Set 107.654321 MHz Center Frequency (CF)			
Input		Temporary Register	CF Register
0=High	1=Low		
Data:	D ₁ 0001(1) D ₂ 0010 (2)	00 00 00 00 00	Last Input
	Temporary Command	21 00 00 00 00	Last Input
Data:	D ₁ 0011 (3) D ₂ 0100 (4)	21 00 00 00 00	Last Input
	Temporary Command	43 21 00 00 00	Last Input
Data:	D ₁ 0101 (5) D ₂ 0110 (6)	43 21 00 00 00	Last Input
	Temporary Command	65 43 21 00 00	Last Input
Data:	D ₁ 0111 (7) D ₂ 0000 (0)	65 43 21 00 00	Last Input
	Temporary Command	07 65 43 21 00	Last Input
	Address: D ₁ 1111 (15) D ₂ 0000 (0)	01 07 65 43 21	Last Input
	Transfer Command	00 00 00 00 00	01 07 65 43 21
EXAMPLE 3. Set 120 dB Attenuation (RF SECTION) Below +13 dBm (1 volt)			
Input		Temporary Register	Atten Register
0=High	1=Low		
Data:	D ₁ 0010 (2) D ₂ 0001 (1)	00 00 00 00 00	Last Input
	Temporary Command	12 00 00 00 00	Last Input
	Address: D ₁ 1111 (15) D ₂ 0011 (3)	12 00 00 00 00	Last Input
	Transfer Command	00 00 00 00 00	120
NOTE			
The attenuator is a three-digit register; only the three most significant digits are retained.			

Table 3-3. Model 8660C Programming Examples (2 of 3)

EXAMPLE 4. Set 7 dB Attenuation (RF SECTION) Below +13 dBm (1 volt)			
Input 0=High 1=Low		Temporary Register	Atten Register
Data:	D ₁ 0000 (0) D ₂ 0111 (7)	00 00 00 00 00	Last Input
Temporary Command		70 00 00 00 00	Last Input
Data:	D ₁ 0000 (0) D ₂ 0000 (0)	70 00 00 00 00	Last Input
Temporary Command		00 70 00 00 00	Last Input
Address:	D ₁ 1111 (15) D ₂ 0011 (3)	00 70 00 00 00	Last Input
Transfer Command		00 00 00 00 00	007
See note for Example 3			
EXAMPLE 5. Shut off Modulation (MODULATION SECTION)			
Input 0=High 1=Low		Temporary Register	Function Register
Address:	D ₁ 1111 (15) D ₂ 0100 (4)	00 00 00 00 00	Last Input
Transfer Command		00 00 00 00 00	00
NOTE: All digits are zero - no modulation			
EXAMPLE 6. Set 3% AM Modulation, Internal 1 kHz (MODULATION SECTION)			
Input 0=High 1=Low		Temporary Register	AM-FM % Register
Data:	D ₁ 0011 (3) D ₂ 0000 (0)	00 00 00 00 00	Last Input
Temporary Command		03 00 00 00 00	Last Input
Address:	D ₁ 1111 (15) D ₂ 0101 (5)	03 00 00 00 00	Last Input
Transfer Command		00 00 00 00 00	03 into % Storage
Data:	D ₁ 0001 (1) D ₂ 1000 (8)	00 00 00 00 00	
Temporary Command		81 00 00 00 00	
Address:	D ₁ 1111 (15) D ₂ 0100 (4)	81 00 00 00 00	
Transfer Command		00 00 00 00 00	81 into AM-FM Function Register Sets AM and 1 kHz
NOTE: See Table 3-4. for AM-FM Function Register Codes			

Table 3-3. Model 8660C Programming Examples (3 of 3)

EXAMPLE 7. Set 10 MHz STEP ↑			
Input 0=High 1 = Low		Temporary Register	INCR Register
Data: D ₁ 0000 (0)	D ₂ 0001 (1)	00 00 00 00 00	Last Input
Temporary Command		10 00 00 00 00	Last Input
Data: D ₁ 0000 (0)	D ₂ 0000 (0)	10 00 00 00 00	Last Input
Temporary Command		00 10 00 00 00	Last Input
Address: D ₁ 1111 (15)	D ₂ 0001 (1)	00 10 00 00 00	Last Input
Transfer Command		00 00 00 00 00	00 10 00 00 00

Table 3-4. AM - FM Function Register Coding

DIGIT 2 (D ₂) 0=High 1=Low		DIGIT 1 (D ₁) 0=High 1=Low	
ØM	1100 (12)	EXT. AC (UNLEVELED)	1001 (9) 86633 only
FM X .1	0100 (4)	EXT. DC	0100 (4)
FM X 1	0010 (2)	INT. 400 Hz	0010 (2)
FM X 10	0001 (1)	INT. 1 kHz	0001 (1)
OFF	0000 (0)		

Table 3-5. Programming Connections to J3

J3 Pin No.	To A3XA5 Pin No.	Signal	Other
1			To J3 pin 18
3	2	Error	
5	5	LCL-RMT	
9	11	Command	
13	15	Digit 1 - 8	
14	16	Digit 1 - 4	
15	17	Digit 1 - 2	
16	18	Digit 1 - 1	
17	A	Flag (Busy)	
24	J	Reset	
28	S	Digit 2 - 8	
29	T	Digit 2 - 4	
30	U	Digit 2 - 2	
31	V	Digit 2 - 1	
36			Ground

J3 pins not listed are also wired to A3XA5. See the rear interface board schematic diagram for wiring information.

HP-IB uses many of the operational parameters (coding, handshake, etc.), the terms HP-IB and ASCII should not be used interchangeably because they are not completely compatible.

3-46. The HP-IB interface systems use seventeen lines to effect the transfer of data between the instruments connected to the bus. Eight of these lines are used for the actual transfer of data, one line is ground and the remaining eight lines are used for control.

3-47. Table 3-6 illustrates the HP-IB bus interface line designations. The ground line, being self-explanatory, is not shown.

3-48. The structure and operation of the bus is analogous to an old-fashioned party line, and many of the conventions which apply to a party line apply to the HP-IB interface as well. For instance, at any given time only one person may talk on the party line, while many people may listen, and most will not be using the party line at all.

3-49. Similarly, on the HP-IB interface, only one instrument may talk (send data) at any given time, although many instruments may listen (receive data), and most instruments will not interact with the bus at all.

3-50. In order to determine which instruments are to "talk", which are to "listen", and which are to remain inactive, some sort of a controller is required. This controller, which might be a calculator, assigns functions to the various instruments by sending data over the eight lines to all instruments. Any instrument becomes a listener when its listen address is placed on the bus and remains a listener until the "unlisten" command is transmitted. Talkers, on the other hand, stop functioning as talkers whenever another talk address is put on the data lines. This prevents more than one device from talking at any given time.

3-51. In order for the instrument to distinguish between data and addresses, both of which are sent over the eight data lines, an "address mode/data mode" selector called the Multiple Response Enable (MRE) line is driven by the controller. When this line is low, all instruments listen to the eight data lines and interpret the information being transmitted by the controller as addresses. When the MRE line is high, information on the eight data lines is interpreted as data and the instruments talk, listen or remain inactive as determined during the time they were addressed when MRE was low.

3-52. Three-Wire Handshake. Information, whether addresses, measurement results, or other data is transferred on the data lines under control of a technique called the three-wire handshake. The handshake involves the use of three control lines, and operates as follows:

a. A listener indicates that it is ready to accept data by letting the Ready for Data (RFD) line go high. Listeners are connected to the RFD line in a logical AND configuration so the RFD line does not go high until all active listeners are ready for data.

b. After RFD has gone high, the talker indicates that it has placed a data byte on the eight data lines by setting the Data Valid (DAV) line low.

c. After DAV has gone low, each listener pulls RFD low, accepts the data, and then lets the data accepted (DAC) line go high. Again, all listeners are logically ANDed and DAC does not go high until all listeners have accepted the data.

d. After the DAC line has gone high, the talker can let DAV go high again and take the data off the lines. When DAV goes high, the listeners set DAC back to low and the sequence is ready to repeat with step 1 of Figure 3-4.

3-53. As can be seen from the description, data transfer is asynchronous, proceeding only as fast as the slowest active (addressed to talk or listen) device on the line.

NOTE

Figure 3-4 illustrates a flow chart of the three-wire handshake operation.

3-54. The four remaining control lines operate as follows:

a. The Remote Enable (REN) line allows the controller to put all instrument on the bus in the remote mode. When this line is low, all instruments will go into remote as soon as they are addressed, and remain in remote until the line goes high again.

b. The End Output (EOP) line, when pulled low by the system controller, will halt all activity on the bus and cause all instruments to unaddress themselves.

Table 3-6. HP-IB Interface Lines

	<u>Name</u>	<u>Abbreviation</u>	<u>Description</u>
D A T A	Data Input/Output 1	DI01	These lines carry address data, basic measurement data, control and program data, and status data.
	Data Input/Output 8	DI08	
T R A N S F E R	Data Valid	DAV	These lines control the transfer of data over the DI01-DI08 lines.
	Ready for Data	RFD	
	Data Accepted	DAC	
M A N A G E M E N T	Multiple Response Enable	MRE	Indicates whether information on DI01-DI08 should be interpreted as data common to all instruments (addresses) or data directed to selected instruments.
	Remote Enable	REN	Switches all instruments between remote and local mode.
	End Output	EOP	Allows controller to halt communication over the bus.
	Service Request	SRQ	Allows instruments on the bus to get the attention of the controller.
	End or Identify	EOI	Enables the controller to determine which instrument requested service through the SRQ line.

c. The Service Request (SRQ) line allows instruments to get the attention of the controller. The Model 8660C does not use this line, so its function will not be described here.

d. The End OR Identify (EOI) line is used to identify which instrument pulled the SRQ line low. The Model 8660C does not use this line.

3-55. When a standard Model 8660C is modified to accept the HP-IB interface the instructions contained in the modification kit must be followed to install the two new circuit boards.

3-56. In addition to following the modification instructions, special care should be taken to observe jumper positions on the HP-IB boards.

3-57. Before installing the HP-IB circuit boards check the address jumpers, and change if required. It should be noted that if more than one Model

8660C is used in a system, it is not likely that operational parameters will be the same for each, so different addresses will probably be required for each instrument.

3-58. When used in the Model 8660C, jumper J2 must not be connected.

3-59. Jumper J1 is installed at the operator's choice. With it in place the internally generated BUSY signal is used to delay the RFD response. Without it, the operator must make allowances in programming for the necessary settling time of the Model 8660C.

3-60. The information contained in this section of this manual applies only to Model 8660C Option 005 HP-IB instruments. Refer to Table 3-7 for HP-IB codes. Information contained in this section for other types of remote control does not apply to Option 005 instruments.

3-61. Local control operation of Option 005 instruments is the same as that described for the Model 8660C in other parts of this section.

3-62. Basically, the Model 8660C Option 005 instruments are the same as the standard Model 8660C instruments except that the capability of remote operation using the HP-IB interface is added and BCD interface is deleted. Basic information about HP-IB is included in the General Information Section of this manual.

3-63. Option 005 allows remote programming via the HP-IB interface of all 8660C front panel controls except LINE, (POWER), SWEEP MODE, and MANUAL MODE. All front panel controls except LINE AND FM CAL are locked out when the Model 8660C is in remote.

3-64. The Model 8660C HP-IB interface will recognize an internally preset "listen" address and accept bit-parallel, word serial HP-IB information. When addressed to listen, the Model 8660C shifts incoming data into a temporary storage register. This data must be presented to the interface least significant digit first to satisfy the internal logic

requirements of the Model 8660C. When a programming code is detected in the input data, the contents of the temporary storage register are shifted into the register selected by the internal address character. The temporary register is then cleared to make way for more data.

3-65. There are three separate modulation parameters which may be programmed; source, type and %. Source and type are combined into one number (source is the least significant digit) and this number is followed by the address "\$". To turn off the modulation section, code 0 for modulation type. When programming AM, % modulation refers to percentage of full scale. Thus the FM X 10 range is 1000 kHz full scale, and 20% would mean 200 kHz deviation. With this setup the deviation of the 86632B or the 86635A would be 400 kHz.

3-66. One last convention is that after the Model 8660C is placed in remote, the first output of the HP-IB interface should be a false address which serves to clear the temporary storage register. This can be accomplished by first addressing the Model 8660C to listen, then placing "/" on the HP-IB line.

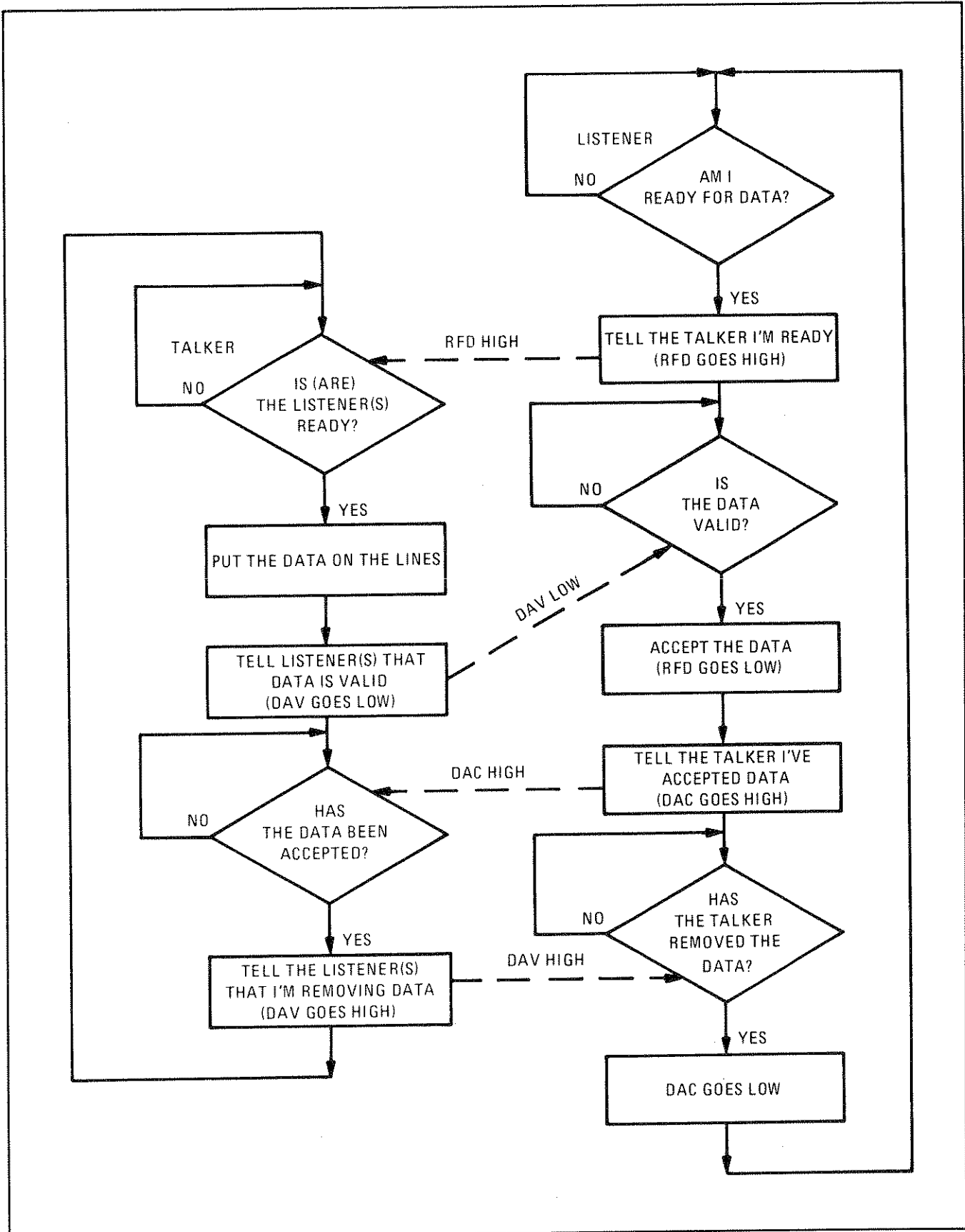
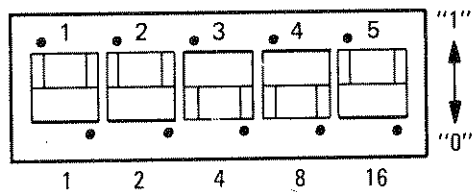

Figure 3-4. Handshake Flow Chart

Table 3-7. HP-IB Code Allocations

DIO LINES		UNIVERSAL BUS COMMANDS			DEVICE LISTEN ADDRESS		DEVICE TALK ADDRESS													
8	→	x [H] H			x [H] L		x [H] L		x [L] H		x [L] H									
7	→																			
6	→																			
5	→																			
		COLUMN → 0			1	2	3	4	5											
4	↓	ROW ↓	OCTAL	DECIMAL	BUS	COMMAND	OCTAL	DECIMAL	SYMBOLIC	ADDRESS	OCTAL	DECIMAL	SYMBOLIC	ADDRESS	OCTAL	DECIMAL	SYMBOLIC	ADDRESS		
3	↓		0	0.			20	16.				60	48.	0	100	64.	@	120	80.	P
2	↓		1	1.			21	17.	*LLO			61	49.	!	101	65.	A	121	81.	Q
1	↓		2	2.			22	18.	R*			62	50.	"	102	66.	B	122	82.	R
			3	3.			23	19.	R*			63	51.	#	103	67.	C	123	83.	S
			4	4.			24	20.	DCR			64	52.	\$	104	68.	D	124	84.	T
			5	5.			25	21.				65	53.	%	105	69.	E	125	85.	U
			6	6.			26	22.				66	54.	&	106	70.	F	126	86.	V
			7	7.			27	23.	UNAS- SIGNED			67	55.	'	107	71.	G	127	87.	W
			8	8.			30	24.	SPE			70	56.	(110	72.	H	130	88.	X
			9	9.			31	25.	SPD			71	57.)	111	73.	I	131	89.	Y
			10	10.			32	26.				72	58.	:	112	74.	J	132	90.	Z
			11	11.			33	27.				73	59.	;	113	75.	K	133	91.	[
			12	12.			34	28.	R*			74	60.	<	114	76.	L	134	92.	\
			13	13.			35	29.	R*			75	61.	=	115	77.	M	135	93.]
			14	14.			36	30.				76	62.	>	116	78.	N	136	94.	^
		15	15.			37	31.				77	63.	?	117	79.	0	137	95.	-	
										UNLISTEN COMMAND								UNTALK COMMAND		

H = High State. LLO = Local Lockout. SPE = Status Poll Enable. [] = Control Bits.
 L = Low State. DCR = Device Clear. SPO = Status Poll Disable.
 X = Unused when MRE is low. R* = Reserved for future assignments. DIO = Data Input Output Signal Lines, DIO1-8.



† Figure 3-5. HP-IB Address Switch S1 with Factory Set ASCII Address Code 3 Selected (19₁₀). (Shown as mounted in 8660C on A3A2 assembly.)

Table 3-8. 8660 HP-IB Coding Table

		Function	HP-IB Character	
I N T E R N A L	A D D R E S S	{ CENTER FREQUENCY STEP↑ STEP↓ OUTPUT LEVEL MODULATION MODE/SOURCE MODULATION LEVEL ¹ FM CALIBRATE ² }	(
			A	
			B	
			C	
			\$	
			&	
M O D U L A T I O N	M O D E	{ OFF FM X 10 ² FM X 1 ¹ FM X 0.1 ¹ AM ^{1,3} φM ⁴ }	M S D	0
				1
				2
				4
				8 < ⁶
	S O U R C E	{ INT 1 KHZ ¹ INT 400 HZ ¹ EXT DC EXT AC EXT AC UNLEVELED ⁵ }	L S D	1
				2
				4
				8
				9
H P - I B S Y S T E M	A D D R E S S E S	{ 8660 LISTEN ADDRESS (FACTORY SELECTED) OTHER POSSIBLE LISTEN ADDRESS OTHER POSSIBLE LISTEN ADDRESS OTHER POSSIBLE LISTEN ADDRESS }	for multiple units	3
				;
				=
				>
				?
	D I G I T S	{ 0 1 2 3 4 5 6 7 8 9 }		Controller Dependent ⁷
				0
				1
				2
				3
4				
5				
6				
7				
8				
9				

¹ Not used in 86634A

² 86632 and 86635A only

³ Not used in 86635A

⁴ 86634A and 86635A only

⁵ 86633 only

⁶ Use ≤ on 9820 Calculators

⁷ Use DISPLAY 4 on 9820 calculators; decimal 20 in binary format on 9830 calculators.



HEWLETT PACKARD

SALES & SERVICE OFFICES

AFRICA, ASIA, AUSTRALIA

AUSTRALIA
Hewlett-Packard Australia Pty. Ltd.
31-41 Joseph Street
Blackburn, Victoria 3130
P.O. Box 36
Doncaster East, Victoria 3109
Tel: 893951
Telex: 31-024
Cable: HEWPARD Melbourne
Hewlett-Packard Australia Pty. Ltd.
31 Bridge Street

Perkside, S.A., 5063
Tel: 2725911
Telex: 82539
Cable: HEWPARD Adelaide
Hewlett-Packard Australia Pty. Ltd.
141 Stirling Highway
Plymble
New South Wales, 2073
Tel: 4486566
Telex: 21561
Cable: HEWPARD Sydney
Spring Hill, Queensland 4000
Tel: 2291544
Cable: HEWPARD Brisbane

Nedlands, W.A. 6009
Tel: 3865455
Telex: 93859
Cable: HEWPARD Perth
Hewlett-Packard Australia Pty. Ltd.
121 Wollongong Street
Fyshwick, A.C.T. 2609
Tel: 804244
Telex: 62650
Cable: HEWPARD Canberra
Hewlett-Packard Australia Pty. Ltd.
5th Floor
Teachers Union Building
495-499 Boundary Street
Spring Hill, Queensland 4000
Tel: 2291544
Cable: HEWPARD Brisbane

JAPAN
Yokogawa-Hewlett-Packard Ltd.
Chuo Bldg., 4th Floor
4-20, Nishinakajima 5-chome
Yodogawa-ku, Osaka-shi
Osaka 532
Tel: 06-304-6021
Telex: 523-3624
Yokogawa-Hewlett-Packard Ltd.
29-21, Takaido-Higashi 3-chome
Suginami-ku, Tokyo 168
Tel: 03-321-6111
Telex: 232-2024 YHP-Tokyo
Cable: YHPMARKET TOK 23 724
Yokogawa-Hewlett-Packard Ltd.
Nakano Building
24 Kami Sasajima-chome
Nakamura-ku, Nagoya, 450
Tel: 052 571-5171
Yokogawa-Hewlett-Packard Ltd.
2-24-1 Tsuruya-cho
Kanagawa-ku

Yokohama, 221
Tel: 045-312-1252
Telex: 3882-3204 YHP YOK
Yokogawa-Hewlett-Packard Ltd.
Mito Mitsui Building
105, 1-chome, San-no-maru
Mito, Ibaragi 310
Tel: 0292-25-7470
Yokogawa-Hewlett-Packard Ltd.
Inoue Building
1348-3, Asahi-cho, 1-chome
Atsugi, Kanagawa 243
Tel: 0462-24-0452
Yokogawa-Hewlett-Packard Ltd.
Kumagaya Asahi
Hachiroji Building
4th Floor
3-4, Tsukuba
Kumagaya, Saitama 360
Tel: 0485-24-6563

TAIWAN
Hewlett-Packard Far East Ltd.
Tawan Branch
39 Chung Hsiao West Road
Section 1, 7th Floor
Taipei
Tel: 3819160-9, 3141010
Cable: HEWPACK TAIPEI
Hewlett-Packard Far East Ltd.
Tawan Branch
68-2, Chung Chang 3rd. Road
Kaohsiung
Tel: (07) 242316-Kaohsiung
Analytical Only
San Kwang Instruments Co., Ltd.
20 Yung Sui Road
Taipei
Tel: 361546-9 (4 lines)
Telex: 22884 SANKWANG
Cable: SANKWANG Taipei

OTHER AREAS NOT LISTED, CONTACT:
Hewlett-Packard International
3200 Hillview Ave.
Palo Alto, California 94304
Tel: (415) 856-1501
TWX: 910-373-1267
Cable: HEWPACK Palo Alto
Telex: 034-8300, 344-6493

CANADA

ALBERTA
Hewlett-Packard (Canada) Ltd.
116204 - 168th Street
Edmonton T5M 3T9
Tel: (403) 452-3670
TWX: 610-831-2431

BRITISH COLUMBIA
Hewlett-Packard (Canada) Ltd.
10691 Shellbridge Way
Richmond BC V6X 4W7
Tel: (604) 270-2727
TWX: 610-925-5059

MANITOBA
Hewlett-Packard (Canada) Ltd.
380-350 Century St.
Winnipeg R3M 0V1
Tel: (204) 786-6701
TWX: 610-671-3531

NOVA SCOTIA
Hewlett-Packard (Canada) Ltd.
800 Windmill Road
Dartmouth NS B3B 1L3
Tel: (902) 469-7820
TWX: 610-271-4820

ONTARIO
Hewlett-Packard (Canada) Ltd.
1020 Morrison Dr.
Ottawa K2H 6K7
Tel: (613) 820-6483
Telex: 610-963-1636
Hewlett-Packard (Canada) Ltd.
6877 Goreway Drive
Mississauga L4V 1M8
Tel: (416) 678-9430
TWX: 610-492-4246
Hewlett-Packard (Canada) Ltd.
552 Newbold Street
London N6E 2S5
Tel: (519) 686-9181

QUEBEC
Hewlett-Packard (Canada) Ltd.
275 Hymus Blvd.
Pointe Claire H9R 1G7
Tel: (514) 423-4232
TWX: 610-422-3022
TLX: 05-821-11 MPCL

FOR CANADIAN AREAS NOT LISTED:
Contact Hewlett-Packard (Canada) Ltd. in Mississauga.

EUROPE, NORTH AFRICA AND MIDDLE EAST

FRANCE
Hewlett-Packard France
Avenue des Tropiques
Les Ulis
Route Postale No. 6
91401 Orsay-Cedex
Tel: (1) 67 28 25
TWX: 600048F
Hewlett-Packard France
Chemin des Moulins
B.P. 162
99130 Ecully
Tel: (78) 33 91 25,
TWX: 310617F
Hewlett-Packard France
Pérenne de la Cédre
31081 Toulouse-Le Mirail
Tel: (61) 40 11 12
TWX: 510937F
Hewlett-Packard France
Le Ligoures
Bureau de vente de Marseilles
Place Route de Villeneuve
3100 Aix-en-Provence
Tel: (42) 59 41 92

Hewlett-Packard France
2, Allée de la Bourgnette
35100 Rennes
Tel: (99) 51 42 44
TWX: 740912F
Hewlett-Packard France
16, rue du Canal de la Marne
67000 Schiltigheim
Tel: (88) 83 08 10
TWX: 890141F
Hewlett-Packard France
Immeuble pérenne
Rue van Gogh
59650 Villeneuve D Ascq
Tel: (20) 91 41 25
TWX: 160124F
Hewlett-Packard France
Bureau de Vente
Centre d'affaires Paris-Nord
Bâtiment Empereur
Rue de la Commune de Paris
B.P. 300
93153 Le Blanc Mesnil Cédex
Tel: (01) 931 88 50

Hewlett-Packard France
Av. du Pdt. Kennedy
33700 Mérignac
Tel: (56) 97 22 69
Hewlett-Packard France
"Franc-Evry" immeuble Lorraine
Boulevard de France
91035 Evry-Cadex
Tel: 027 96 60
Hewlett-Packard France
60, Rue de Metz
57130 Jouy aux Arches
Tel: (87) 69 45 32
GERMAN FEDERAL REPUBLIC
Hewlett-Packard GmbH
Vertriebszentrale Frankfurt
Bernier Strasse 117
Postfach 350 140
D-6900 Frankfurt 56
Tel: (0611) 50-04-1
Cable: HEWPACSA Frankfurt
Telex: 04 13249 hpfm d
Hewlett-Packard GmbH
Technisches Büro Böblingen
Herrnberg Strasse 110
D-7030 Böblingen, Württemberg
Tel: (0703) 567-1
Cable: HEWPACK Böblingen
Telex: 07265739 bbn

Hewlett-Packard GmbH
Technisches Büro Düsseldorf
Emanuel-Leutze-Str. 1 (Seestern)
D-4000 Düsseldorf
Tel: (0211) 59711
Telex: 08586 533 hpfm d
Hewlett-Packard GmbH
Technisches Büro Hamburg
Wendenstrasse 23
D-2000 Hamburg 1
Tel: (040) 124 13 93
Cable: HEWPACSA Hamburg
VIA Turazza 14
35100 Padova
Hewlett-Packard GmbH
Technisches Büro Hannover
Am Grossmarkt 6
D-3000 Hannover 91
Tel: (0511) 46 90 01
Tel: (051) 54 69 61
Cable: HEWPACK Roma
Telex: 61514
Hewlett-Packard GmbH
Technisches Büro Nürnberg
Neumeyerstrasse 90
D-8500 Nürnberg
Tel: (0911) 56 30 83
Telex: 0823 860

Hewlett-Packard GmbH
Technisches Büro München
Eschenstrasse 5
D-8021 Taufkirchen
Tel: (089) 6117-1
Hewlett-Packard GmbH
Technisches Büro Berlin
Kalthstrasse 2-4
D-1000 Berlin 30
Tel: (30) 24 90 86
Telex: 018 3405 hpfm d
ITALY
Hewlett-Packard Italiana S.p.A.
Via G. D. Vittorio, 9
20053 Serusico
Sul Naviglio (MI)
Tel: (2) 903691
Telex: 311046 HEWPACKIT
Hewlett-Packard Italiana S.p.A.
Via Turazza 14
35100 Padova
Tel: (49) 664888
Telex: 41612 HEWPACKI
Hewlett-Packard Italiana S.p.A.
Via G. Armellini 10
I-00143 Roma
Tel: (06) 54 69 61
Cable: HEWPACKIT Roma
Telex: 668068
Hewlett-Packard Italiana S.p.A.
Corso Giovanni Lanza 94
I-10133 Torino
Tel: (011) 682245/659308

Medical Calculators Only
Hewlett-Packard Italiana S.p.A.
Via Principe Nicola 43 G.C.
I-95126 Catania
Tel: (095) 37 05 04
Hewlett-Packard Italiana S.p.A.
Via Nuova San Rocco A.
Capodimonte, 62A
I-80131 Napoli
Tel: (081) 7913544
Hewlett-Packard Italiana S.p.A.
Via E. Mattei, 9/B
I-40132 Bologna
Tel: (051) 307987/300040
UNITED KINGDOM
Hewlett-Packard Ltd.
King Street Lane
Winnesh, Wokingham
Berks. RG11 5AR
Tel: (0734) 704774
Telex: 847 178-9
Hewlett-Packard Ltd.
Trafalgar House
Navigation Road
Aldrichham
Chesham, Bucks. MK14 1NU
Tel: (051) 928 6422
Telex: 668068
Hewlett-Packard Ltd.
Lygon Court
Hereford Road
Dudley Road

Halesowen,
West Midlands B62 8SD
Tel: (021) 550 9911
Telex: 339105
Hewlett-Packard Ltd.
Wedge House
799, London Road
Thornton Heath
Surrey CR4 6XL
Tel: (81) 6840103
Telex: 946825
Hewlett-Packard Ltd.
30, Wesley St.
Castletford
Yorks WF10 1AE
Tel: (0977) 550016
Telex: 557355
Hewlett-Packard Ltd.
1, Wallace Way
Hitchin
Hertfordshire, SG4 0SE
Tel: (0462) 31111
Telex: 62 59 61
**FOR OTHER AREAS
NOT LISTED CONTACT**
Hewlett-Packard S.A.
7, rue du Bois-du-Lan
P.O. Box
CH-1217 Meyrin 2 - Geneva
Switzerland
Tel: (022) 92 70 00

UNITED STATES

ALABAMA
P.O. Box 4207
8290 Whitesburg Dr.
Huntsville 35892
Tel: (205) 881-4591
8933 E. Roebuck Blvd
Birmingham 35206
Tel: (205) 836-2203/2
ARIZONA
2336 E. Magnolia St.
Phoenix 85034
Tel: (602) 244-1361
2424 East Aragon Rd
Tucson 85706
Tel: (602) 889-4661
ARKANSAS
Medical Service Only
P.O. Box 5646
Brady Station
Little Rock 72215
Tel: (501) 376-1844
CALIFORNIA
1579 W. Shaw Ave.
Fresno 93711
Tel: (209) 224-0582
1430 East Orangethorpe Ave.
Fullerton 92631
Tel: (714) 870-1000
3939 Lankershim Boulevard
North Hollywood 91604
Tel: (213) 877-1282
TWX: 910-499-2671
*Los Angeles
Tel: (213) 776-5000
3003 Scott Boulevard
Santa Clara 95050
Tel: (408) 968-7000
*Ridgecrest
Tel: (818) 446-6165
645 W. North Market Blvd
Sacramento 95834
Tel: (916) 929-7222

9606 Aero Drive
P.O. Box 23333
San Diego 92123
Tel: (714) 279-3200
*Tarzane
Tel: (213) 705-3444
COLORADO
Jacksonville 6250
Englewood 80110
Tel: (303) 771-3455
CONNECTICUT
12 Lunar Drive
New Haven 06525
Tel: (203) 389-6551
TWX: 710-465-2029
FLORIDA
P.O. Box 24210
2727 N.W. 62nd Street
Ft. Lauderdale 33309
Tel: (305) 973-2600
4428 Emerson Street
Unit 103
Jacksonville 32207
Tel: (904) 725-6333
P.O. Box 13910
6177 Lake Ellenor Dr.
Orlando 32809
Tel: (305) 859-2900
P.O. Box 12826
Suite S, Bldg. 1
Office Park North
Pensacola 32575
Tel: (904) 476-8422
GEORGIA
P.O. Box 105005
450 Interstate North Parkway
Atlanta 30348
Tel: (404) 855-1500
Medical Service Only
*Augusta 30903
Tel: (404) 736-0592
P.O. Box 2103
1172 N. Davis Drive
Warner Robins 31098
Tel: (912) 922-0449
HAWAII
2875 So. King Street
Honolulu 96826
Tel: (808) 955-4455

ILLINOIS
5201 Tolliver Dr.
Rolling Meadows 60008
Tel: (312) 255-9809
TWX: 910-687-2260
INDIANA
7301 North Shadeland Ave.
Indianapolis 46250
Tel: (317) 842-1000
TWX: 810-280-1797
IOWA
2415 Heinz Road
Iowa City 52240
Tel: (319) 338-9486
KENTUCKY
Medical Only
3901 Atkinson Dr.
Suite 407 Atkinson Square
Louisville 40218
Tel: (603) 456-1573
LOUISIANA
P.O. Box 1449
3229-39 Williams Boulevard
Kenner 70053
Tel: (504) 443-6201
MARYLAND
7121 Standard Drive
Parkway Industrial Center
Hanover 21076
Tel: (301) 736-7700
TWX: 710-862-1943
2 Choke Cherry Road
Rockville 20850
Tel: (301) 948-6370
TWX: 710-828-9684
MASSACHUSETTS
32 Hartwell Ave.
Lexington 02173
Tel: (617) 861-8960
TWX: 710-326-6904
MICHIGAN
23855 Research Drive
Farmington Hills 48024
Tel: (313) 476-8400
724 West Centre Ave.
Kalamazoo 49002
Tel: (616) 323-8392

MINNESOTA
2400 N. Prior Ave.
St. Paul 55113
Tel: (612) 636-0700
MISSISSIPPI
322 N. Mart Plaza
Jackson 39206
Tel: (601) 982-9363
MISSOURI
11131 Colorado Ave.
Kansas City 64137
Tel: (816) 763-8000
TWX: 910-771-2087
1024 Executive Parkway
St. Louis 63141
Tel: (314) 878-0209
NEBRASKA
Medical Only
716 Mercy Road
Suite 101
Omaha 68106
Tel: (402) 392-0948
NEVADA
*Las Vegas
Tel: (702) 736-6610
NEW JERSEY
W. 120 Century Rd.
Paramus 07652
Tel: (201) 265-5000
TWX: 710-990-4951
Crystal Brook Professional
Building, Route 35
Eastonmont 07724
Tel: (201) 542-1384
NEW MEXICO
P.O. Box 11634
Station E
11300 Lomas Blvd., N.E.
Albuquerque 87123
Tel: (505) 292-1936
TWX: 910-999-1165
156 Wyatt Drive
Las Cruces 88001
Tel: (505) 526-2484
TWX: 910-9983-0550

NEW YORK
6 Automation Lane
Computer Park
Albany 12205
Tel: (518) 458-1550
TWX: 710-444-4961
605 Perinton Hill Office Park
Fairport 14450
Tel: (716) 223-9950
Tel: (716) 253-0092
No. 1 Pennsylvania Plaza
5th Floor
34th Street & 8th Avenue
New York 10001
Tel: (212) 971-0800
5858 East Molloy Road
Syracuse 13211
Tel: (315) 458-2486
1 Crossways Park West
Woodbury 11797
Tel: (516) 921-0300
NORTH CAROLINA
5605 Robone Way
Greensboro 27405
Tel: (919) 852-1800
OHIO
Medical Computer Only
Bldg. 300
1313 E. Kemper Rd.
Cincinnati 45426
Tel: (513) 671-7409
16500 Saragat Road
Cleveland 44130
Tel: (216) 243-7300
TWX: (216) 423-9400
330 Progress Rd.
Dayton 45449
Tel: (513) 859-8202
1041 Kingsmill Parkway
Columbus 43229
Tel: (614) 436-1041
OKLAHOMA
P.O. Box 32008
6301 N. Meridian Avenue
Oklahoma City, 73112
P.O. Box 1270
201 E. Arapaho Rd.
Richardson 75080
Tel: (414) 231-6100
Tulsa 74145

OREGON
10959 SW Lower Boones
Ferry road
Tualatin 97062
Tel: (503) 820-3350
PENNSYLVANIA
111 Zeta Drive
Pittsburgh 15238
Tel: (412) 782-0400
1021 8th Avenue
King of Prussia Industrial Park
King of Prussia 19406
Tel: (215) 265-7000
TWX: 510-960-2970
PUERTO RICO
Hewlett-Packard Inter-Americas
Puerto Rico Branch Office
Calle 272
Edif. 203 Urca Country Club
Carolina 00924
Tel: (809) 762-7255
Telex: 345 0514
SOUTH CAROLINA
P.O. Box 6442
6941-G N Trenton Road
Columbia 29260
Tel: (803) 782-8493
TENNESSEE
8914 Kingston Pike
Tel: (615) 671-7409
16500 Saragat Road
Cleveland 44130
Tel: (216) 243-7300
TWX: (216) 423-9400
330 Progress Rd.
Dayton 45449
Tel: (513) 859-8202
1041 Kingsmill Parkway
Columbus 43229
Tel: (614) 436-1041
TEXAS
4171 North Mesa
Suite C110
Eneo P10 79602
Tel: (915) 553-3555
P.O. Box 1270
201 E. Arapaho Rd.
Richardson 75080
Tel: (414) 231-6100

P.O. Box 42816
10535 Harwin Dr.
Houston 77036
Tel: (713) 776-6409
*Lubbock
Medical Service only
Tel: (806) 799-4472
205 Billy Mitchell Road
San Antonio 78226
Tel: (512) 344-8241
UTAH
2160 South 3270 West Street
Salt Lake City 84119
Tel: (801) 972-4711
VIRGINIA
P.O. Box 12778
Norfolk 23502
Tel: (804) 460-2671
P.O. Box 9669
2914 Hungry Springs Road
Richmond 23228
Tel: (804) 285-3431
WASHINGTON
Bellevue Office Pk.
1203-114th Ave. S.E.
Bellevue 98004
Tel: (206) 454-3971
TWX 910-443-2446
P.O. Box 4010
Spokane 99202
Tel: (509) 535-0864
*WEST VIRGINIA
Medical Analytical Only
Charleston
Tel: (304) 345-1640
WISCONSIN
9004 West Lincoln Ave.
Wauwatosa 53227
Tel: (414) 541-0550

FOR U.S. AREAS NOT LISTED:
Contact the regional office
nearest you: Atlanta, Georgia...
North Hollywood, California...
Rockville, Maryland...Rolling Meadows
Illinois. Their complete
addresses are listed above.

